

# Nursing control JCHN35E



## Data sheet

# Nursing control JCHN35E

- The design of JCHN35E nurse controller is simple and beautiful and easy to use. The hook is improved to a plastic hook and the switch uses a light touch switch, which greatly increases the handle. At the same time, the panel and circuit board can also be interchanged with JCHN35E.
- Realize all-round control of the bed, with up to 23 control buttons
- With lock function optional, increase the safety and comfort of the patient, and improve the efficiency of the nurse
- Could linked with 5 actuators at the same time



---

## Features

- IP grade: IPX4
- Numbers of buttons up to 23
- Touch switch ensures long life.
- Drive up to 5 actuators synchronized
- Color: gray
- Supporting controller: intelligent controllers of Jiecang
- Existing conventional configuration:
  - 4 to 5 function with CPR;
  - JIECANG nurse controller with three columns
- Plug and cable: Option(4m spring wire with 9 pin and 14 pin )
- Panel color and style can be customized

## Usage

- Operating temperature: +5°C to +40°C
- Storage temperature: -10°C to +50°C
- Relative humidity: 20% to 80% - non-condensing
- Atmospheric pressure: 860 to 1060 hPa
- Altitude: Max. 2000m
- Safety certification: RoHS compliant

## Dimension

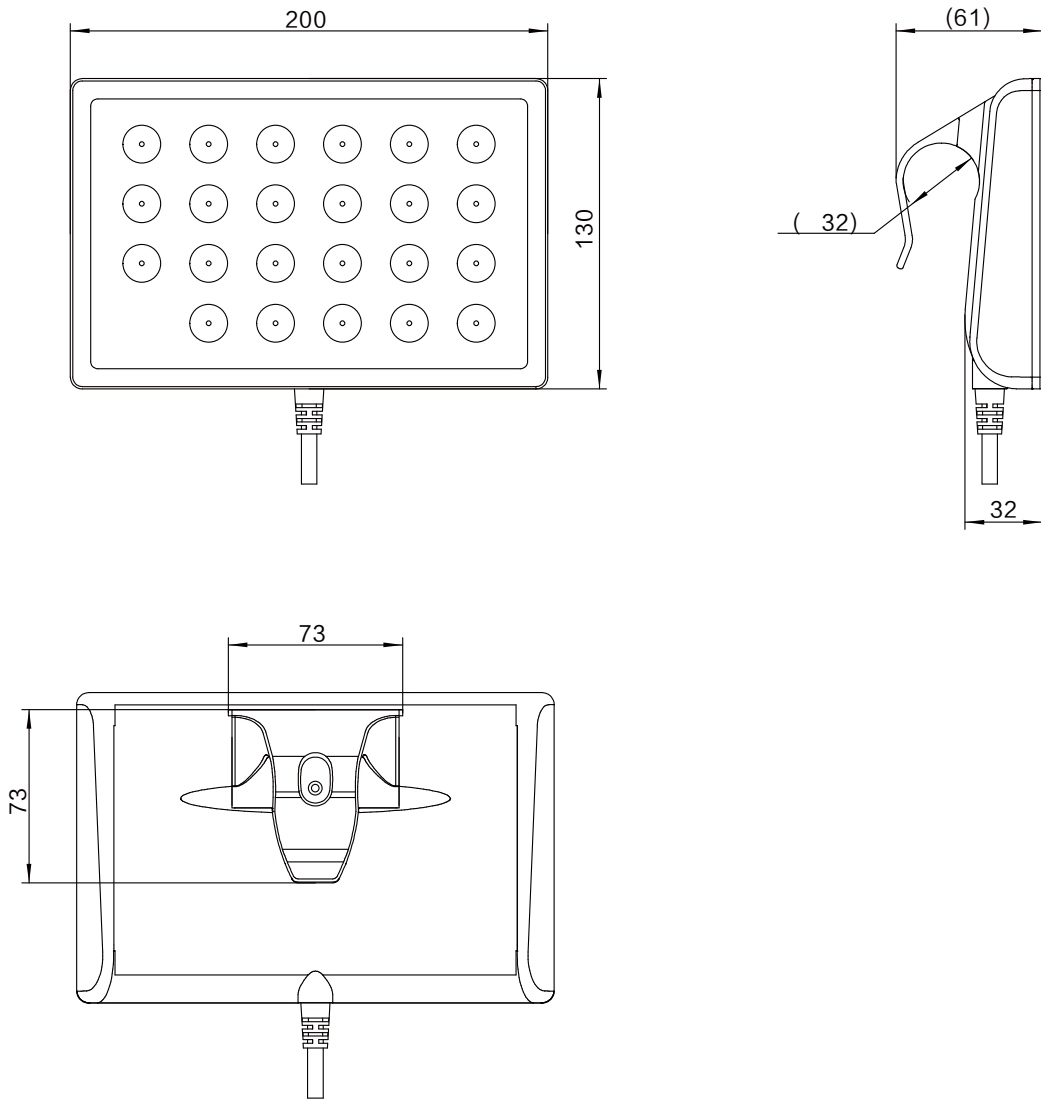

## Ordering Key

JCHN35E - B - 5 - G - 001 - L - 4D0 - L

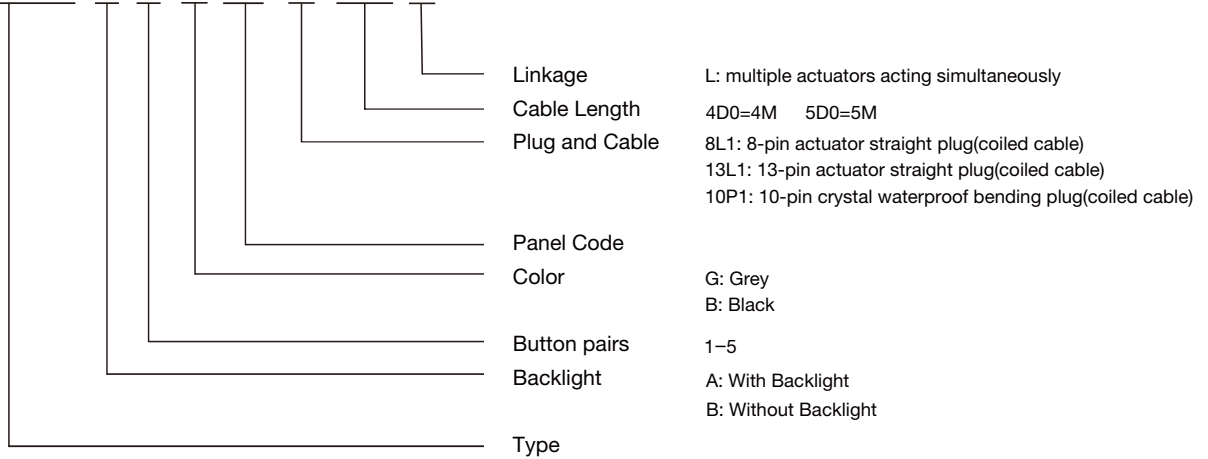

## System diagram

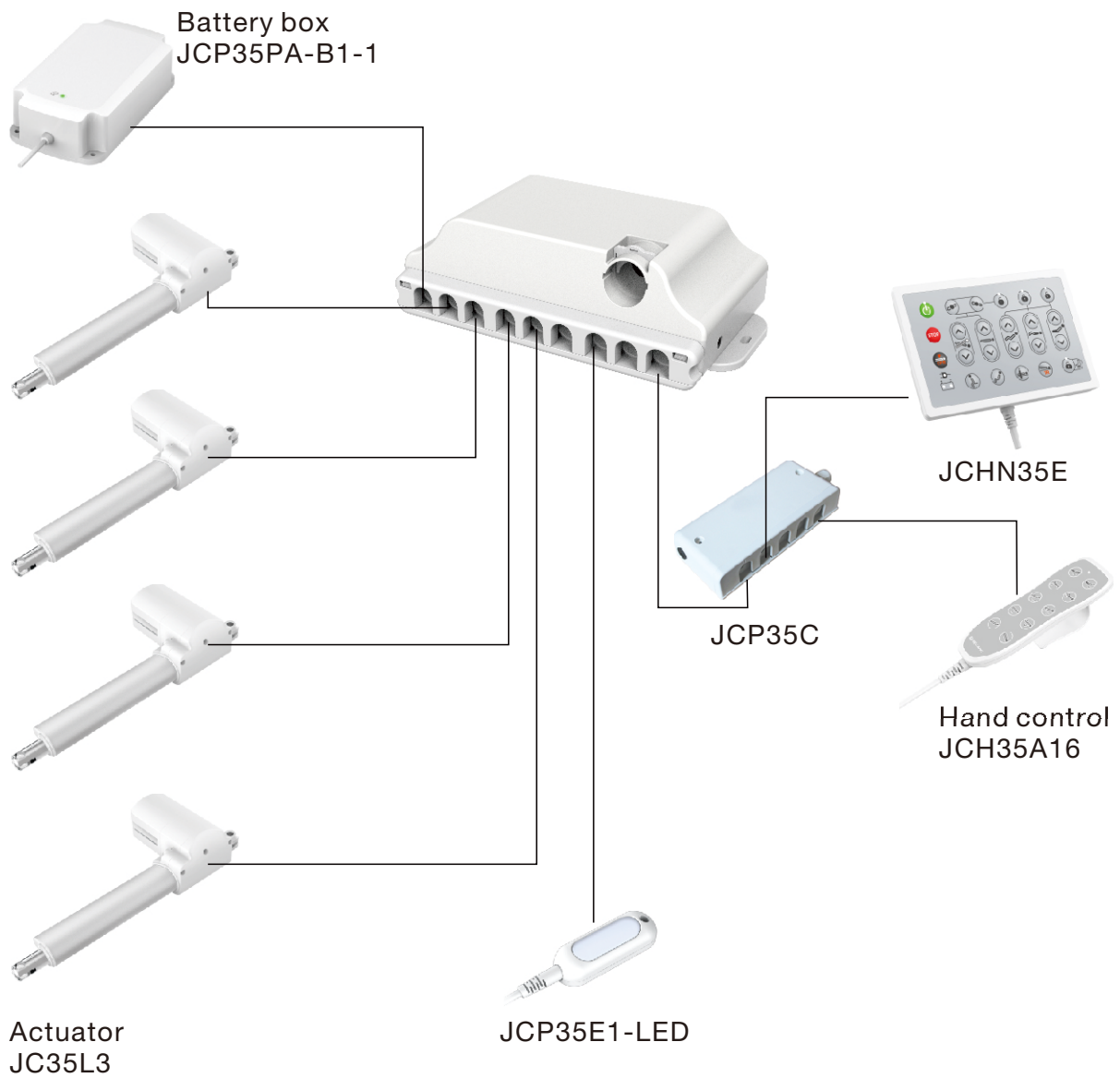

## JCHN35E standard panel:

when placing an order, please check whether the hand control function corresponds to the symbol on the panel.

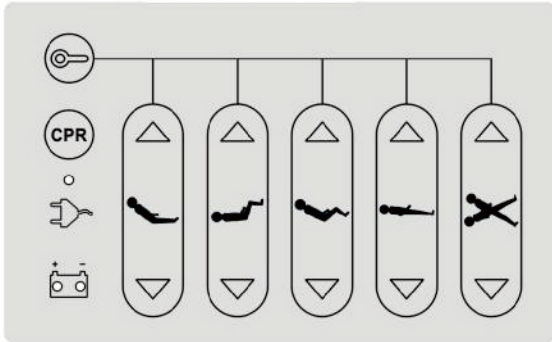

JCHN35E-001

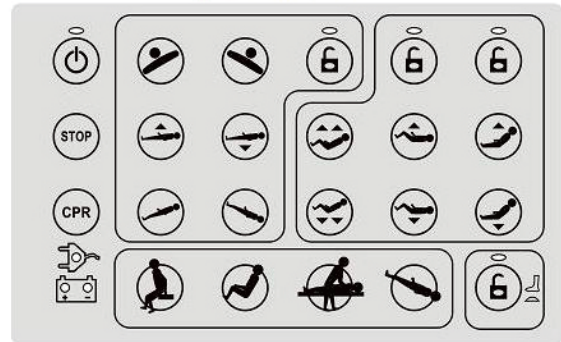

JCHN35E-005



JCHN35E-009

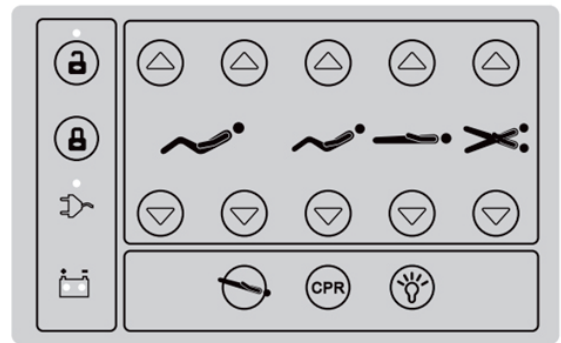

JCHN35E-010

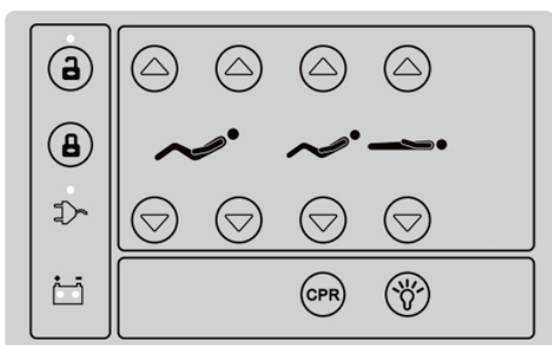

JCHN35E-011

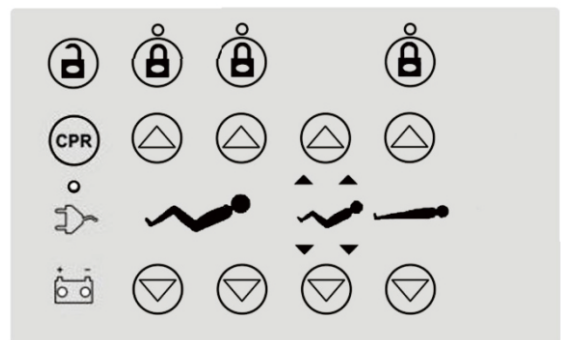

JCHN35E-019

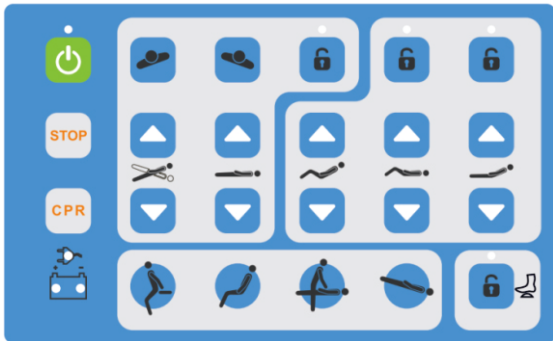

JCHN35E-015



JCHN35E-016

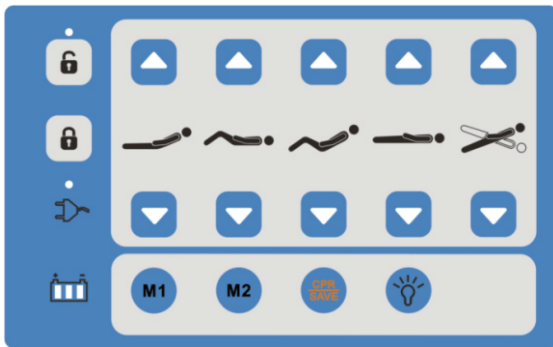

JCHN35E-021

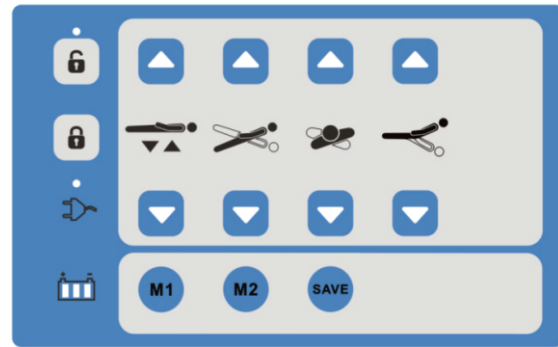

JCHN35E-022

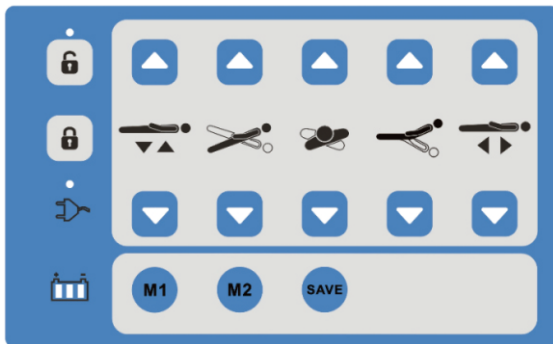

JCHN35E-023

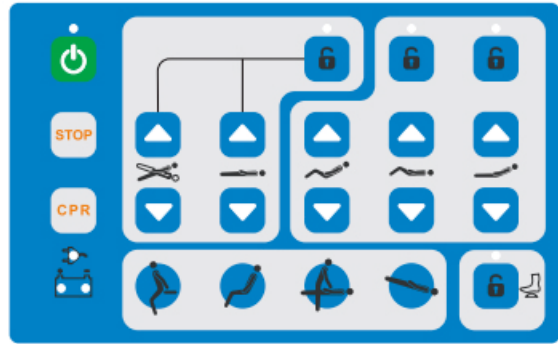

JCHN35E-025

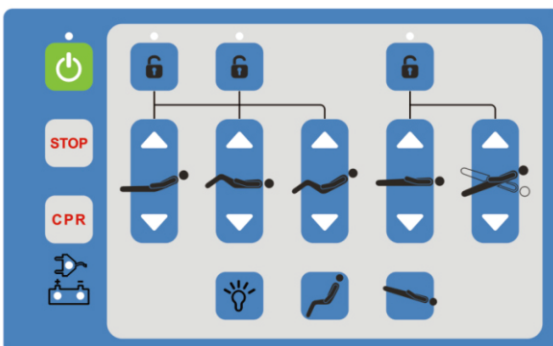

JCHN35E-028

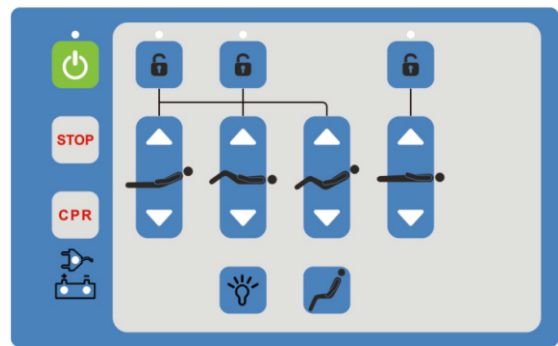

JCHN35E-033

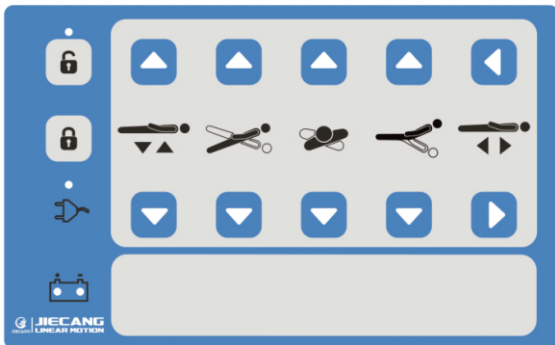

JCHN35E-037

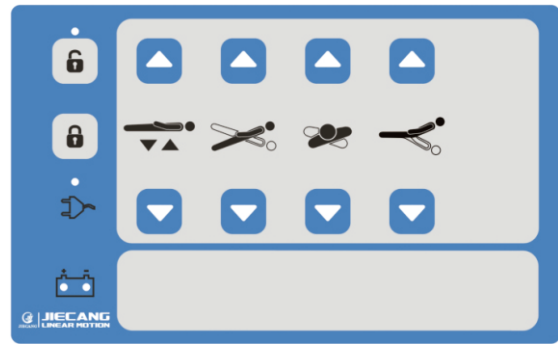

JCHN35E-038

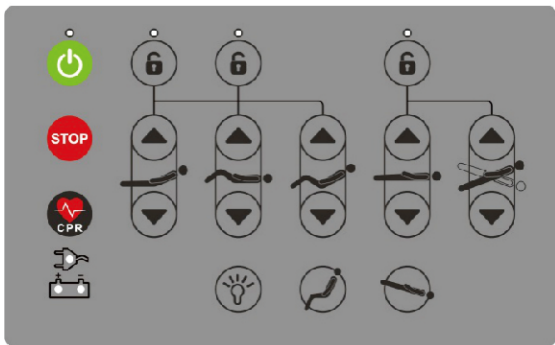

JCHN35E-034

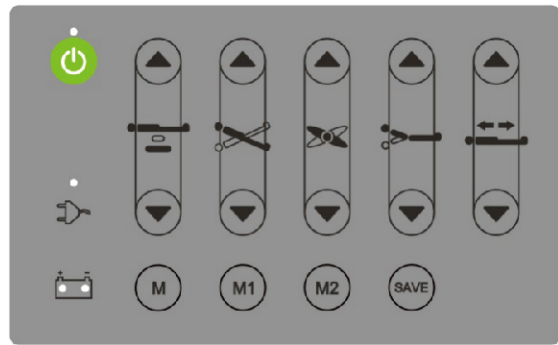

JCHN35E-035

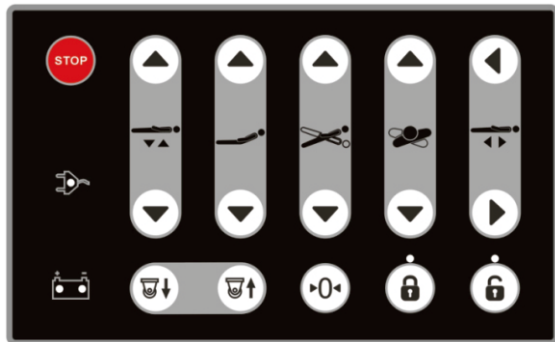

JCHN35E-039

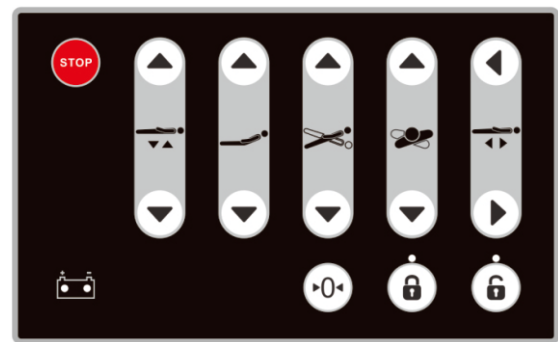

JCHN35E-041



## Plug code

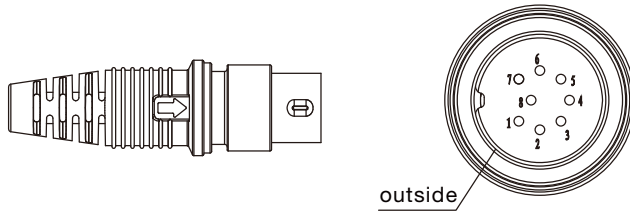

straight cable:8D1

coiled cable:8L1

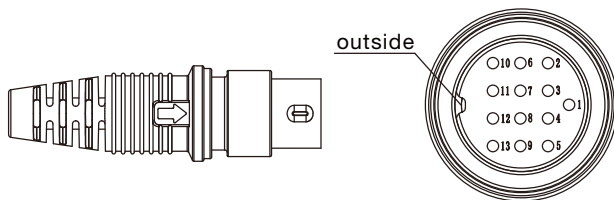

straight cable:13D1

coiled cable:13L1

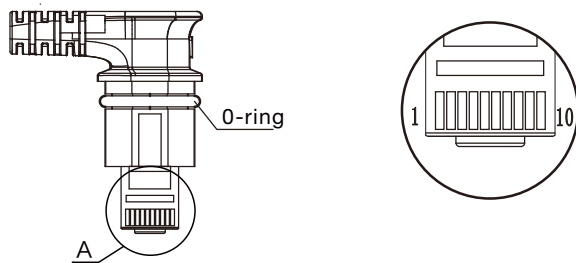

straight cable:10H1

coiled cable:10P1

**\*Attention:**

When the actuator quantity differentiates, the compatible control box as well as the plug would be different.  
So please inquiry for the corresponding salesman in your area before placing an order.