

Nurse Controller JCHN35E1



Data sheet

Nurse Controller JCHN35E1

- JCHN35E1 had compact and light design , easy to use .
The hook is improved to a plastic hook, and the switch uses a metal dome switch, which greatly increases the feel
- All-round bed control ,button amount :Max. 26
- Optional bed control with locking function to increase patient safety and comfort and improve nurse efficiency
- Max. 5 actuators could be linked at the same time



Features

- IP grade: IPX6
- Button amount: Max.26 buttons
- 5 actuators move synchronized
- Color: gray
- Control box: suit with Jiecang control box
- Existing conventional configuration: conventional four-action five-function with CPR; Jiecang three-column nursing control
- Plug and cable: optional(standard:9pin and 14 pin 4 meter coiled cable)
- The color and style of the panel could be designed

Usage

- Operating temperature: +5°C to +40°C
- Storage temperature: -10°C to +50°C
- Relative humidity: 20% to 80%(non-condensing)
- Atmospheric pressure: 860 to 1060 hPa
- Altitude: Max. 2000m
- Safety Certificate: RoHS

Dimensions

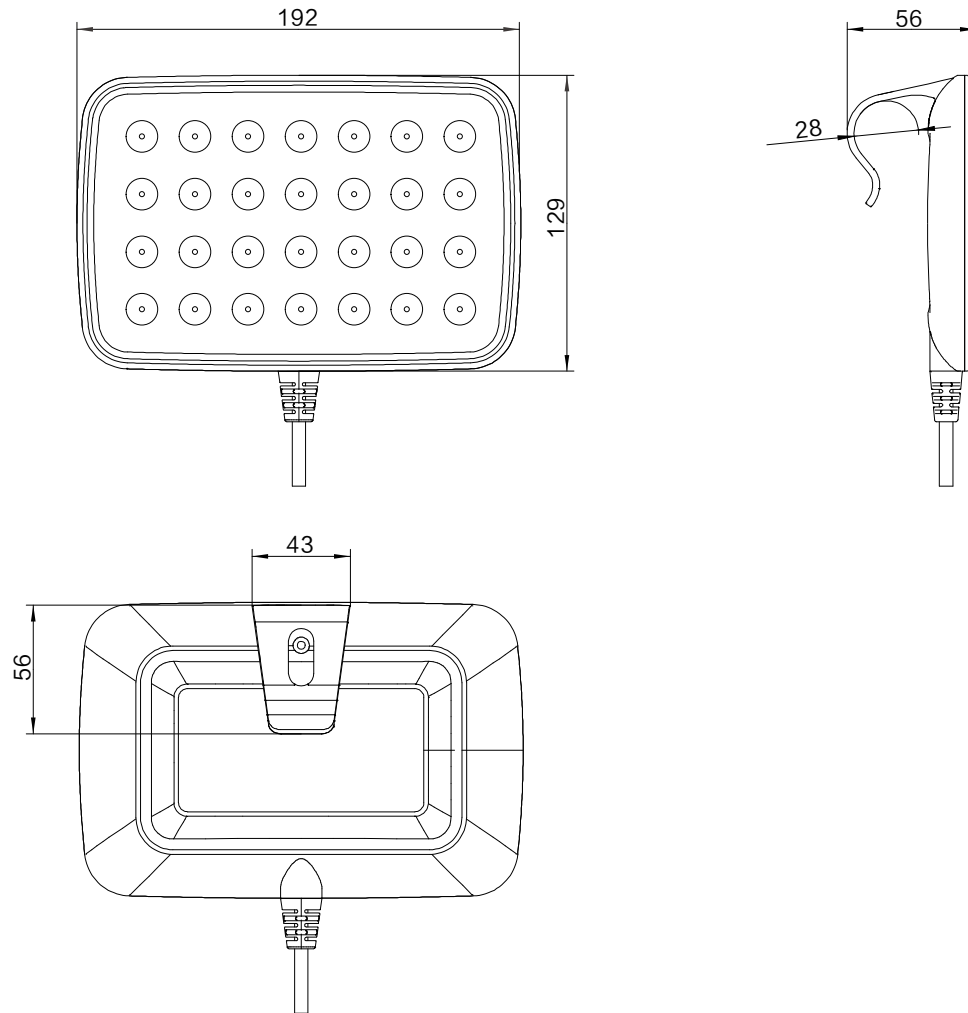

Ordering Key

Model	JCHN35E1	JCHN35E1= E series nursing controller
Extension features	X	A= with backlight B= without backlight
Button row number	X	5=5-row buttons
Color	X	G= grey B= black
Panel code	XXX	5G1=panel code
Plug and Cable	XXX	8L1=8pin Din plug(coiled cable) 13L1=13 pin Din plug(coiled cable) 10P1=10 pin crystal waterproof bending plug(coiled cable)
Cable length	XXX	4D0=4.0M
Linkage way	X	0= single action L= linkage action

Naming regulation

JCHN35E1 - B - 5 - G - 001 - 8L1 - 4D0 - L

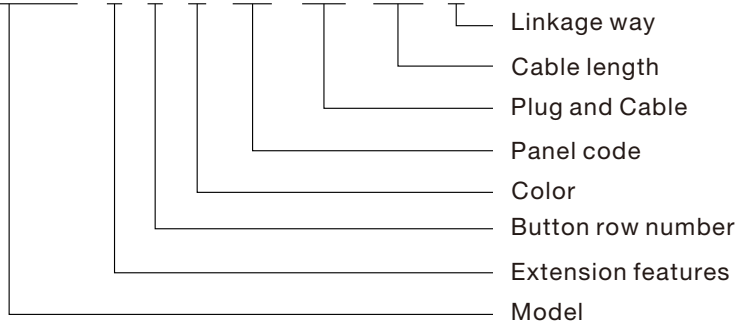

JCHN35E1 system drawing

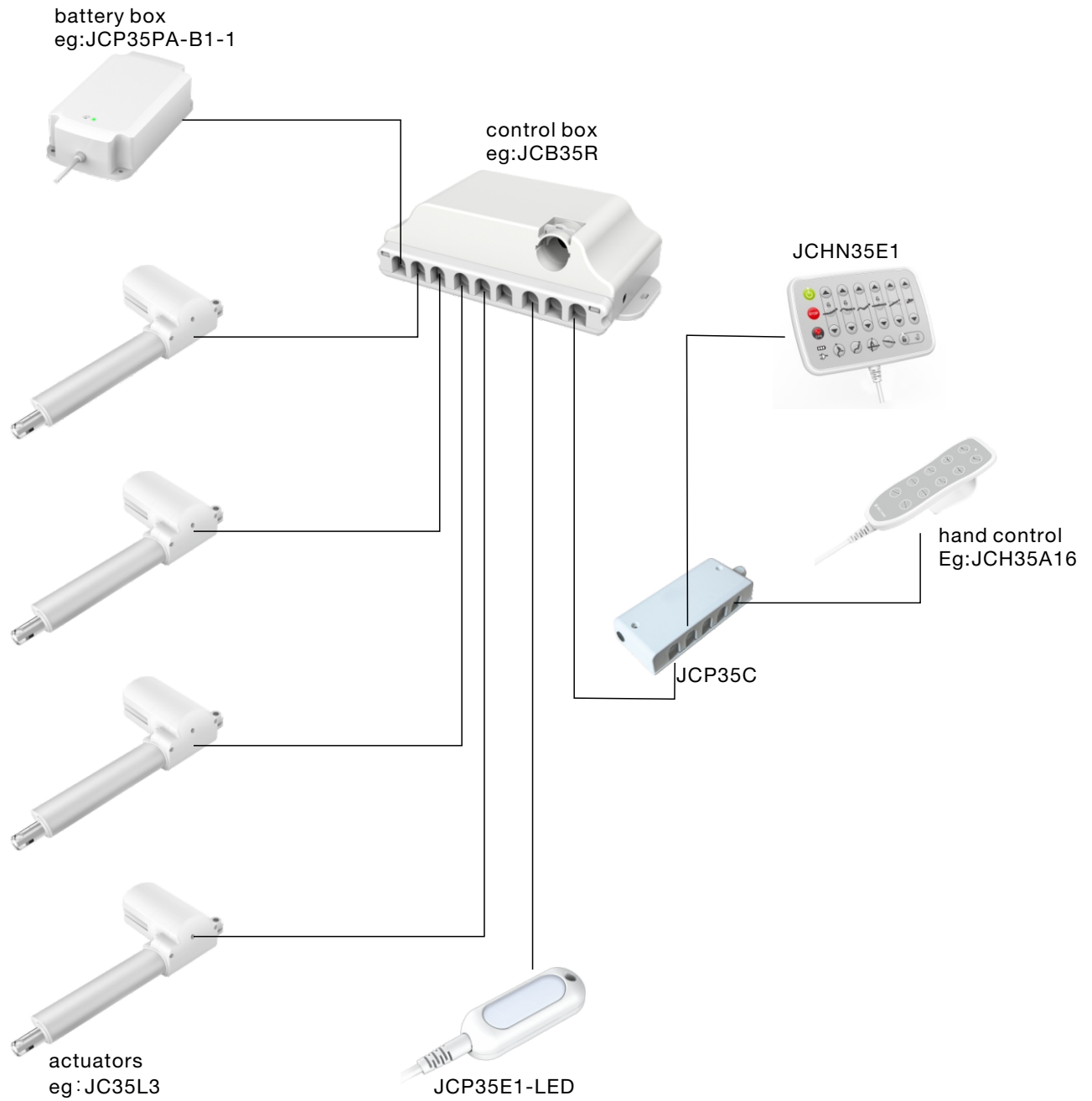

Plug

8pin DIN plug: straight cable 8D1; spring cable: 8L1(matching with JIECANG control boxes of DIN plug)

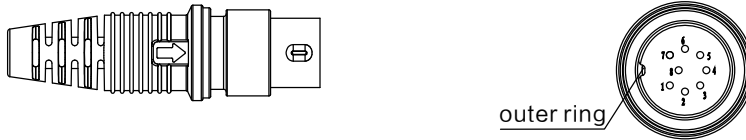

13pin DIN plug: straight cable 13D1; spring cable: 13L1(matching with JIECANG control boxes of DIN plug)

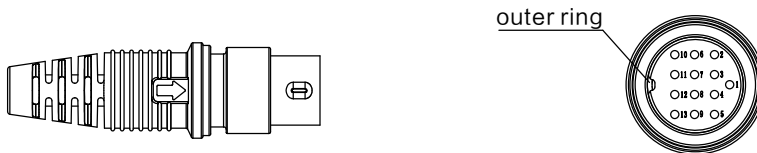

10pin crystal elbow flex plug: straight cable:10H1; Spring cable: 10P1 (matching with JIECANG control boxes JCB35T2, JCB35T3, JCB35T6 of flex plug)

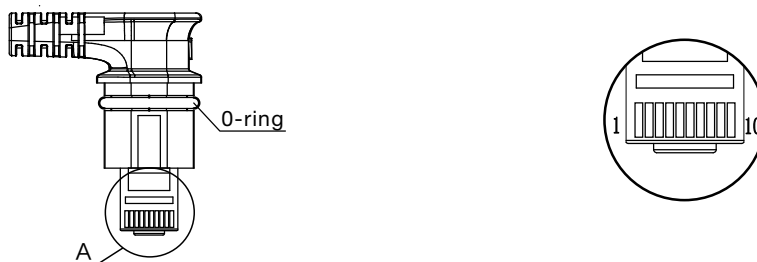

Attention: The model of supporting control box and the plug will be different according to the number of supporting actuators,

Please contact the salesman in the corresponding area of JIECANG for confirmation before placing an order.

JCHN35E1 standard panel

When ordering, please check whether the manual control function corresponds to the symbol on the panel

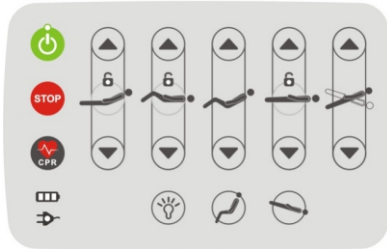

JCHN35E1-001

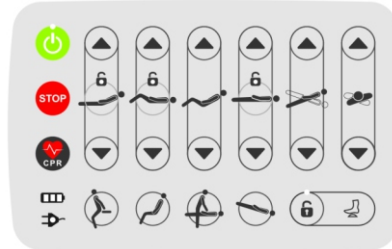

JCHN35E1-003

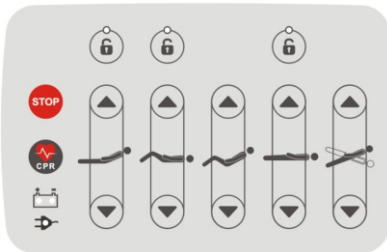

JCHN35E1-007

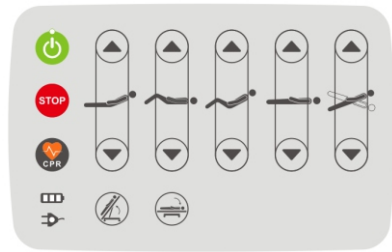

JCHN35E1-013



JCHN35E1-016

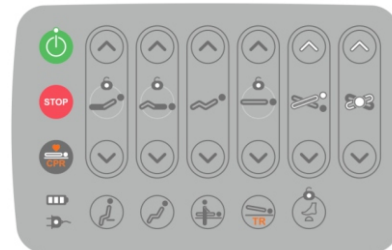

JCHN35E1-022

Disclaimer and Exclusion of Liability

The user must determine the suitability of JIECANG products under specific conditions. JIECANG is committed to providing the latest product information. However, as JIECANG's product are constantly improving, it is possible to make changes to JIECANG's product without prior notice. Therefore, JIECANG cannot guarantee the correctness and authenticity of the product information. Although JIECANG will do its best to meet the order requirements, due to the above reasons, JIECANG cannot guarantee the delivery capacity of any specific product.

Therefore, JIECANG reserves the right to stop selling any products listed on the website or product catalog or other JIECANG written materials. All sales activities must be carried out in accordance with the requirements of JIECANG sales and Delivery Standard Clauses. For copies of relevant documents, please contact JIECANG.